



Grid Wall Panels

*Modular Precision. Acoustic Geometry.
Visual Structure.*



ONNiT Grid Wall Panels

Modular Precision. Acoustic Geometry. Visual Structure.

ONNiT Grid Wall Panels bring order and dimension to vertical surfaces through clean lines, geometric logic, and acoustic performance. Defined by evenly spaced lines that form a continuous square pattern, Grid panels create a structured visual rhythm that enhances both spatial order and sound absorption.



A sculpted grid pattern of intersecting horizontal and vertical channels, offering a balanced, architectural layout with precise rhythm and spatial clarity.

Key Features

- Premium acoustic PET felt construction
- Easy installation with adhesive or mechanical options
- Lightweight and durable
- Seamless design continuity across panels
- Available in 32 standard colors
- Custom color matching and pattern scaling available



Form and Function in Perfect Alignment.

The modular structure of Grid panels makes them ideal for expansive layouts or modular accents. Our team works with you to configure panel sizes, color combinations, and etch alignment for your project needs.

- 1 Installation layout and quantity
- 2 Spacing and orientation
- 3 Installation and mounting preferences
- 4 Color selection and finish direction

1.

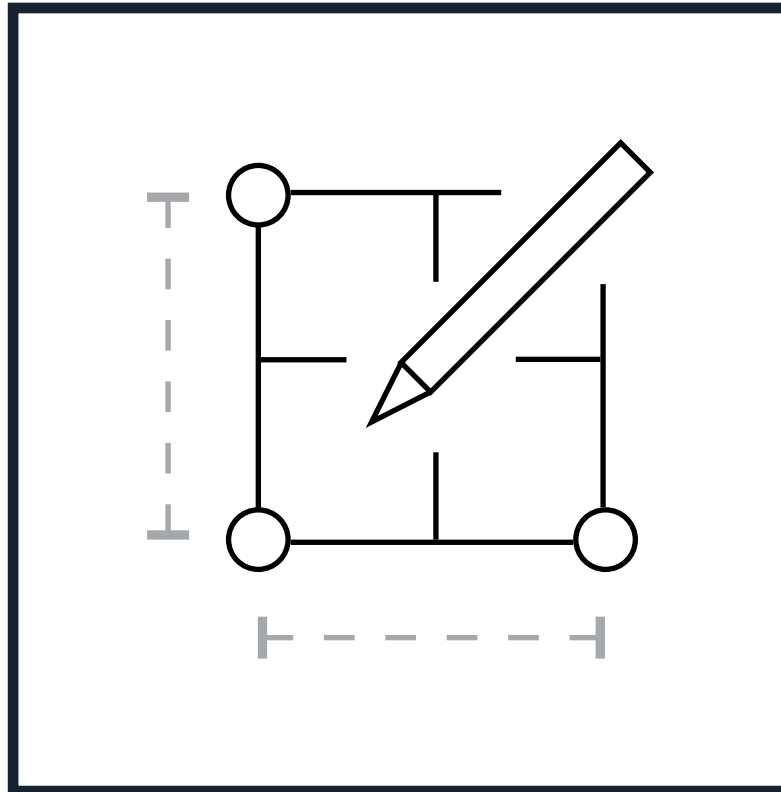

2.

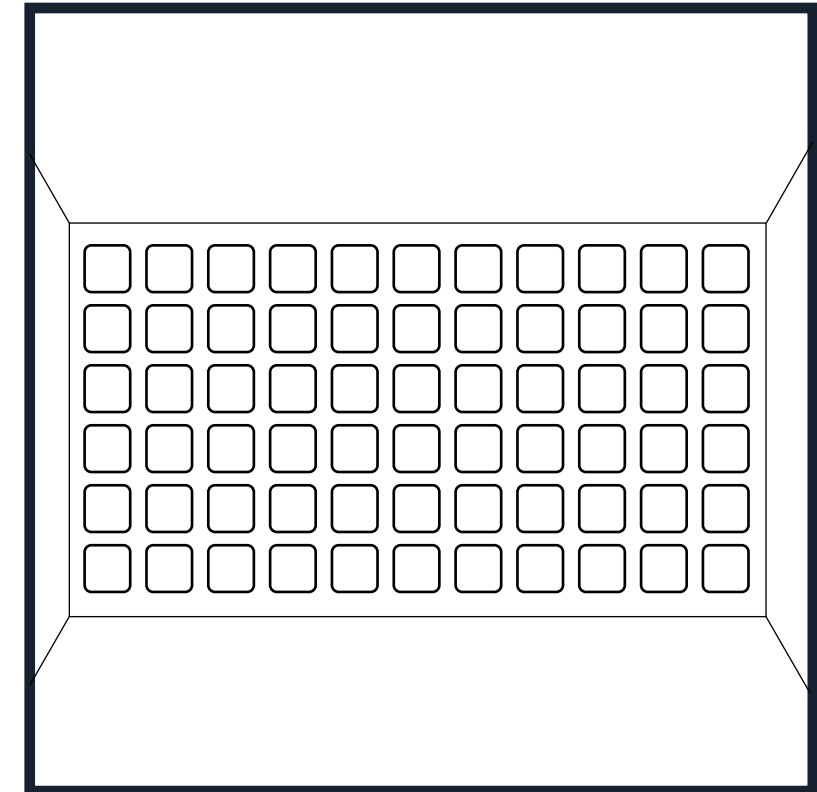

3.

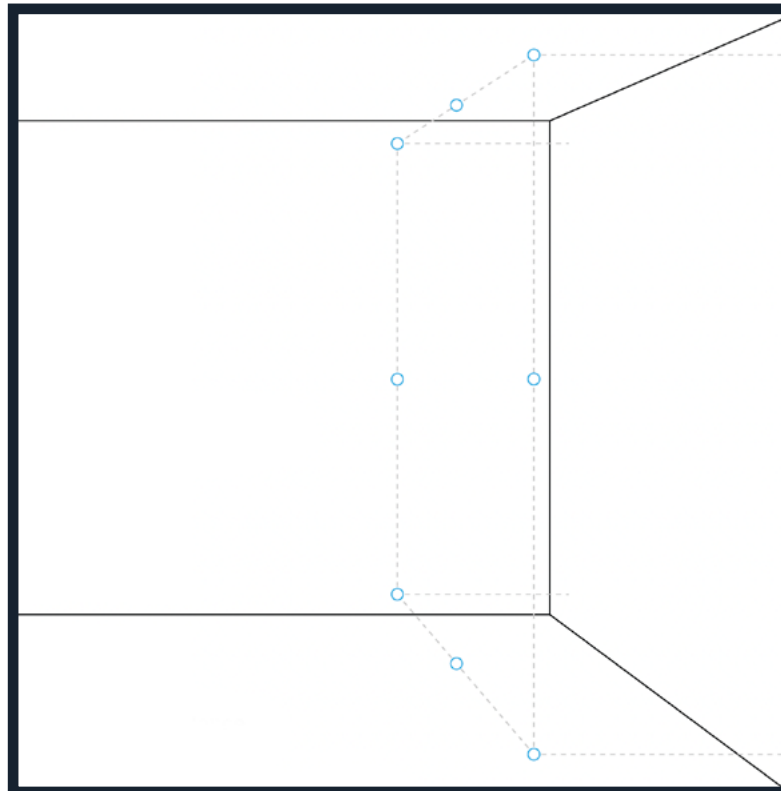

4.

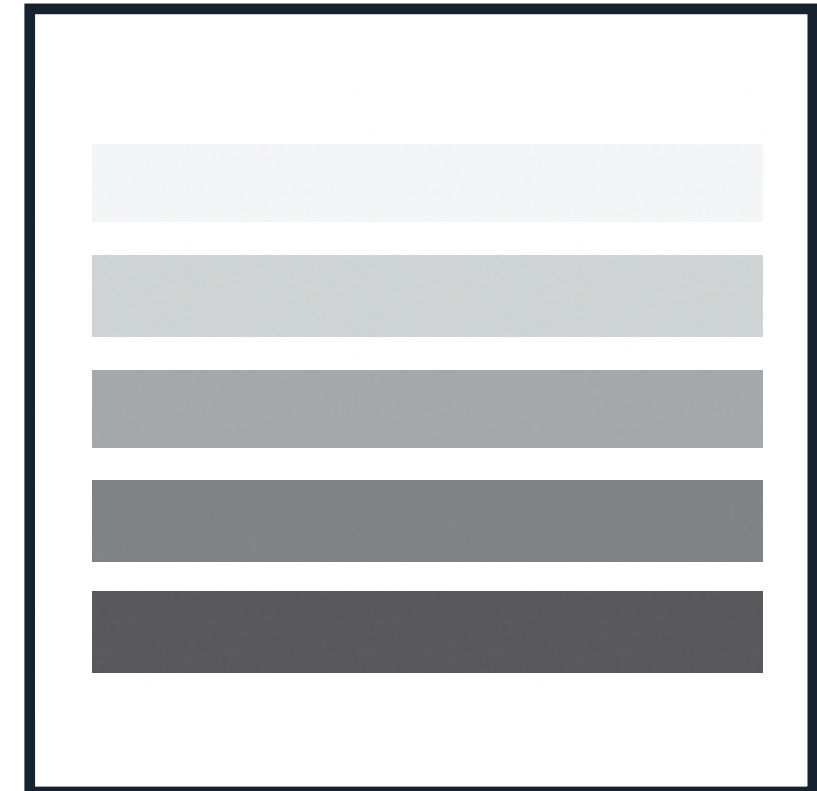

Installation Layout & Quantity

Step 1: Define Your Wall Zone

- Height × Width of intended install area
- Single-wall accent or multi-surface gridscape?

Step 2: Confirm Grid Alignment

- Seamless grid flow across panel seams
- Optional: Custom scaling of grid spacing to fit room dimensions

Step 3: Estimate Quantity

- Use 48" × 96" as a base module
- We are happy to assist in layout planning, takeoffs, and pattern flow continuity

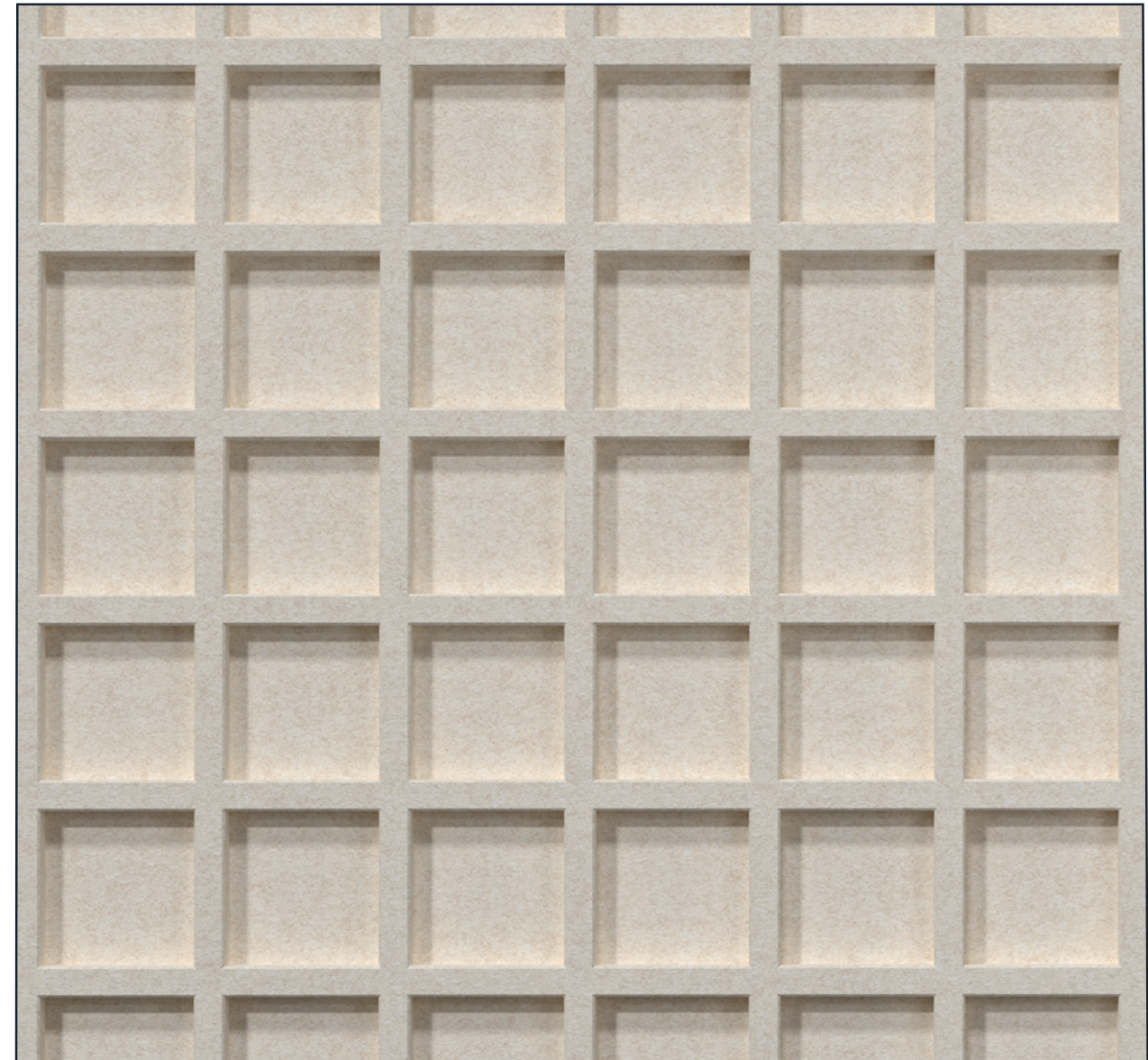

*Installation & Mounting Options -
Simple to Install. Easy to Maintain.*

Mounting Methods:

- **Adhesive (standard):** Clean and fast
- **Screw mount:** Removable and secure
- **Z-clips:** Repositionable panels, ideal for removable installation

Wall Surface Prep:

- Ensure substrate is clean, dry, and level
- Compatible with drywall, wood, concrete or painted surfaces



Spacing & Orientation - Geometry That Moves with the Space.

Orientation Options:

- **Vertical (standard):** Emphasizes height and repetition
- **Horizontal:** Grounds the space, creates structured expansion

Spacing Options:

- **Butt Joint:** Continuous, uninterrupted surface
- **1/4" or 1/2" Reveal:** Creates deliberate shadow lines between panels
- **Segmented Grid Fields:** Use spacing to zone a feature wall

Finish Options - Structure in Color.

Available in ONNiT's full **32 standard PET colors**, including tonal neutrals, rich earth shades, and bold accents.



Sea Salt



Smokey White



Silver Marble



Buckskin

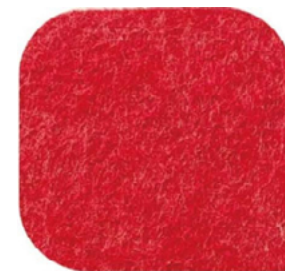

Apple Red



Cranberry



Forest Green



Pacific Blue



Dark Buckskin



Sea Spray



Dark Marble



Coffee



Amethyst



Pear Green



Admiral Blue



Blue Jay



Arizona Sun



Elephant Grey



Aquatic Blue



Lime Green



Arctic Seal



Emerald Green



Azure



Night Blue



Orange Peel



Graphite



Shadow



Jet Black



Black Green



Aruba Blue



Baby Blue



Ash Grey

Custom color matching available upon request

Material Composition

- 100% polyester (PET) felt
- 75% recycled content
- Formaldehyde-free, low-VOC
- Moisture, mold, and mildew resistant

Dimensions and Profile

ATTRIBUTE	DETAIL
Dimensions	Standard Panel Size: 48" W x 96" H
Panel Thickness	9mm design cut panels over 9mm solid panels
Custom Sizing	Available upon request



Use Cases



Sustainability + Compliance

- Made from 75% post-consumer recycled PET
- Made from certified OEKO-TEX® and Global Recycled Standard (GRS) materials
- Formaldehyde-free and low VOC
- Moisture, mold and mildew resistant
- Contributes to LEED MR and EQ credits





Acoustic Performance

- **NRC Rating:** 0.65 – 1.00 (depending on design and layout)
- Independent lab tested (Intertek)
- Based on full-module and multi module installations



Ordering & Customization

- Custom patterns, sizes, and colorways available
- Layout assistance, renderings, and install diagrams
- Quick ship available for select designs
- Contact ONNiT Sales for a quote or sample pack



info@onnitsystems.com

(801) 619-7044



*Visit our online form and
configuration system*